

Fast Start-up, Safely Operate and Efficiently Clean!

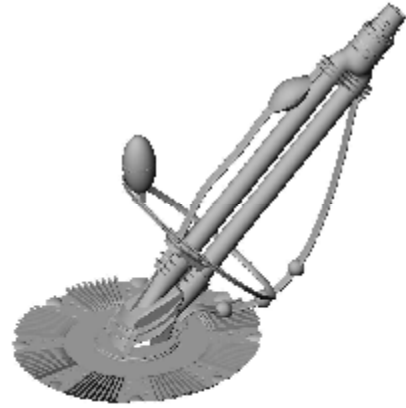

A



B



C



D

Installation and Operation Manual

I. Preparation of Your Pool

Before assembling and installing your cleaner, your pool should be clean and algae-free so as not to inhibit the cleaner's traction. If necessary, make the following preparations before proceeding:

1. Chemically balance the pool water.
2. Brush pool and let the debris settle.
3. Hand vacuum thoroughly.
4. Clean filter and pump strainer basket.

II. Assembly

Remove the body and all of its parts from the box and check to make sure that all components were included. Refer to Figure 1.

Components Check List

No.	Parts list	Model				Qty	Figure 1
		A	B	C	D		
1a	Body A	√		√		1	
1b	Body B		√			1	
1d	Body D				√	1	
2	Dive Float restrictor	√	√	√	√	1	
3	Eyeball diverter and outer ring	√	√	√	√	1	
4	Hose weights	√	√	√	√	3	
5	Automatic regulator valve	√	√	√	√	1	
6	Hose Cone	√	√	√	√	1	
7	Roller bumper strap	√	√	√	√	1	
8a	Pleated seal A	√				1	
8b	Pleated seal B		√		√	1	
8c	Pleated seal C			√		1	
9a	Hoses A				√	10	
9b	Hoses B	√	√	√		1	
9c	Hoses C	√	√	√		9	
10	Wing plate assembly	√		√		1	
11	Adapter				√	1	
Note: "√" representative of the products included in this component							

Step 1. Attach The Seal

To install the seal locate the words “Up”(“TOP”) and face them towards the main body, slip the seal over the foot pad-(flat side down towards pool floor)-and pull gently until it seats itself on the other side in its groove as illustrated in Figure 2. **Seal must be installed flat side down, pleated side up.** Once in place, the seal should rotate and turn freely.

The seal is not reversible. The raised pleats on the Pleated seal must face upward. The flat side of the seal should face down to rest against the pool surface.

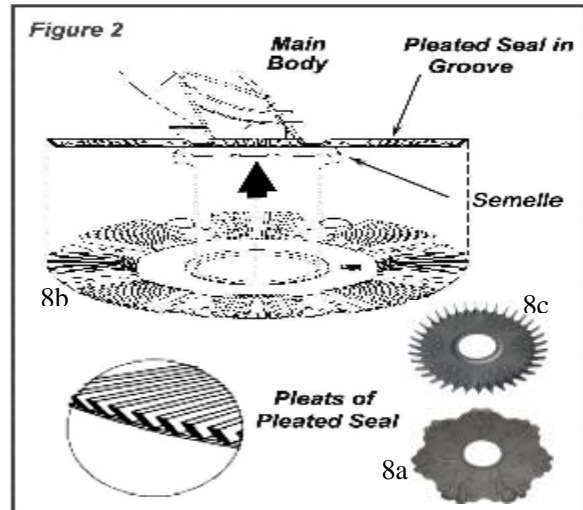

Step 2. Attach The Adapter

The adapter is fitted on the body, see diagram below



Note: This step is only applicable to model# A and C

Step 3. Attach The Roller Bumper Strap

Insert the bottom end of the strap into the slot provided on the main body. Insert the top end of the strap into the locking clip attached to the swivel head. See Figure 3.

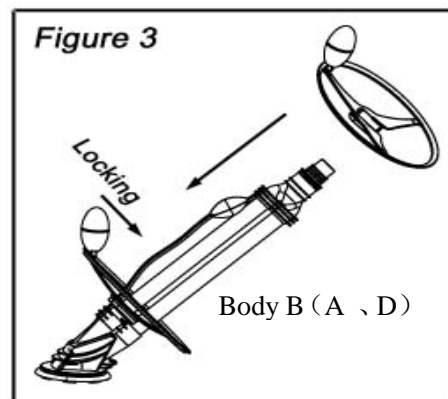

Step 4. Attach The Dive Float Restrictor

Snap the dive float restrictor into the lower U-shaped brace between the dive floats. Make sure the locking tabs on both sides of the dive float restrictor snap securely into place. See Figure 4.

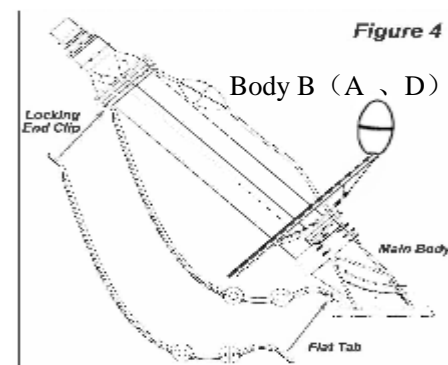

Step 5. Attach The Hose Weights And Assemble The Hose

The cleaner hose comes in sections which must be assembled. You'll need enough sections to reach from where the cleaner is connected, to the farthest part of your pool, plus one section. You will also have to attach hose weights to the hose **to neutralize the hose's buoyancy in water.** The number of hose weights required is determined by the maximum depth of your pool. The deeper your pool, the more weights is needed. The number of hose weights appropriate for your pool is explained in Table A.

Pool depth	Weight Placement
4 feet or less	1 weight: 4 to 12 inches from body's swivel head.
More than 4 feet, but less than 7 feet	2 weights: one 4 to 12 inches and one 6 feet from the swivel head.
More than 7 feet, but less than 12 feet	3 weights: one 4 to 12 inches, one 6 feet and one 10 feet from the swivel head.
More than 12 feet	4 weights:* one 4 to 12 inches, one 6 feet, one 10 feet, and one 12 feet from the swivel head.

Twist and push the female ends onto the male ends after dipping the ends into the pool to wet them. See Figure 5. Continue until you're connected all the sections you need. After connecting the hose weights to the hose as described in "Table A", then connect the hose to the cleaner. See Figure 6.

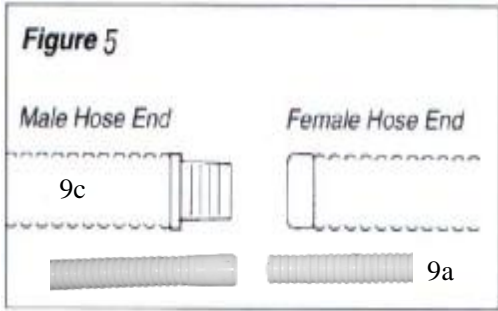

One of the hose sections has 2 female ends and a hose protector. This section should be fitted last and attached to the pool's vacuum connection.

Your fully assembled the cleaner should look like this.

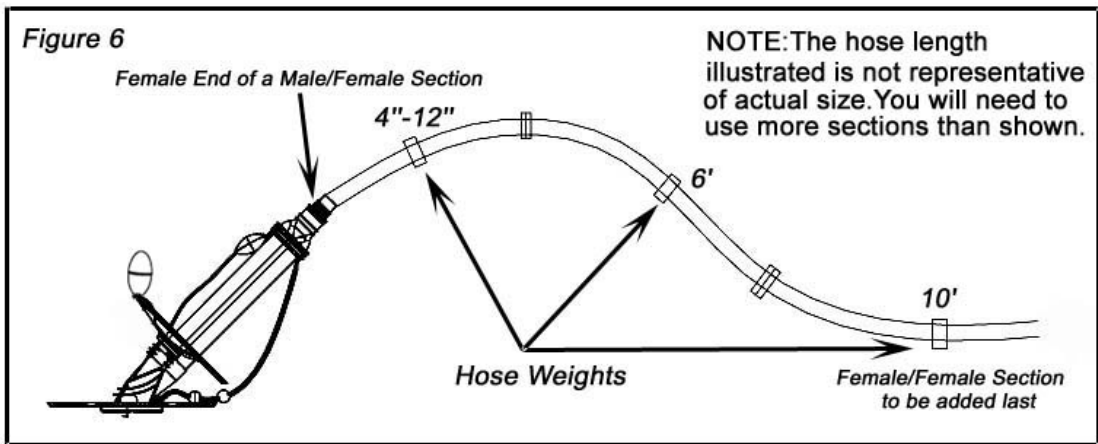

The body is connecting with hose; please refer to the right picture.
Only model# D needs to use an adapter to connect the hose.

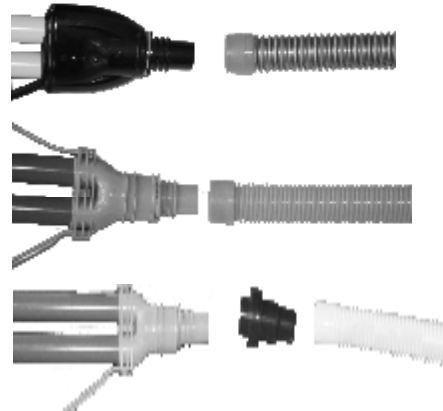

III. Installation

The cleaner is designed to work in a wide variety of swimming pools. That's why we've included certain items (such as a 2" hose cone and valve cap for the automatic regulator valve) with your cleaner. These may or may not be needed, depending on the particular features of your pool.

Both the standard in-skimmer installation and an optional vacuum line installation are covered in this manual. Check to see which most closely fits your pool configuration and follow the directions.

Standard Installation

For pools with one skimmer, using the automatic regulator valve. The advantage of this installation is that the automatic regulator valve automatically balances the water flow between the skimmer and the cleaner. We strongly recommend the use of automatic regulator valve. for maximum safety and performance. The valve automatically adjusts to changes in the amount of water flow to provide the cleaner with the power necessary to ensure proper cleaning performance.

1. Turn the pool pump off.
2. Close the main drain and all suction lines, except the line from the skimmer to which the cleaner will be connected.
3. Remove skimmer basket.
4. Press the 2" hose cone into the vacuum connection in the bottom of the skimmer, as shown in Figure 8.
5. Press the automatic regulator valve into the 2" Hose Cone. The end of the valve that is marked "Attach Hose This End" must point up. See Figure 7.
6. Place the cleaner into the pool and allow it to sink to the floor. Continue to feed the hose vertically down into the pool until it is completely filled with water and purged of air.

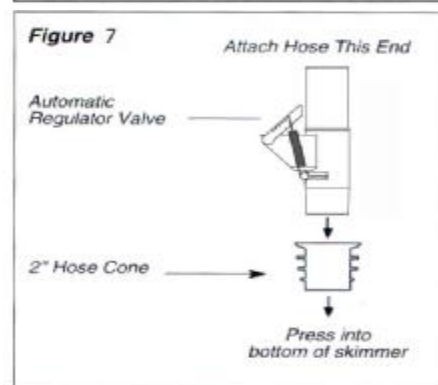
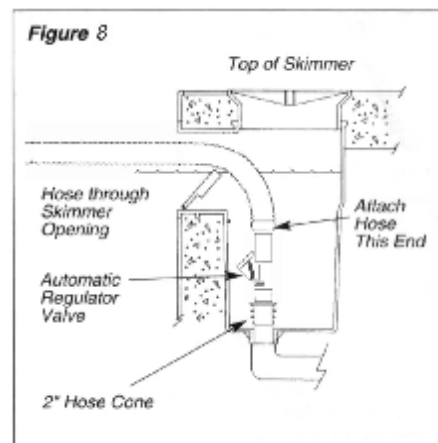

7. Insert the end of the hose through the skimmer opening and connect the hose directly onto the automatic regulator valve.

IV. Adjustments

After completing the installation, **turn the pool pump on**. Allow the pump to run for a couple of minutes to ensure all air cycles out of the system. The cleaner should be moving about the pool at a rate of 8 to 12 feet per minute. Check each of the following initial adjustments to the cleaner at this time.

Hose Length

IMPORTANT: The pump must be on when you check the hose length. The hose contracts when the pump is operating and will be longer when the pump is off.

With the cleaner operating, position it at the furthest point of the pool from where it's attached. (It is easy to position the cleaner the pool by moving it about with your pool pole and brush.) The cleaner's hose should be long enough to reach the end of the pool, plus one hose section. If necessary, remove extra hose sections from the center portion of hose. Removing center hose sections avoids having to disturb the hose weight placement. Save extra hose sections for use as needed for replacement. **NOTE: Turn pool pump off when adding or removing hose sections.**

Hose Balance

To determine correct hose balance, **turn the pump off** and observe the cleaner. Hose balance is correct when the cleaner's seal rests flat on the pool floor and the diver tubes make a 45° angle with the floor, as shown in Figure 9. The cleaner achieves the best cleaning coverage when the hose neither weights down nor pills up on the unit. Adjust hose weights one inch at a time as needed, until proper hose balance is achieved. In pools with both shallow and deep areas, adjust hose weights first in the deep area and then in the shallow area.

1. Hose Too Light. If the hose rises towards the surface at an angle greater than 45° , move the weights closer to the cleaner, or move the first two weights closer to each other.
2. Correct Hose Balance.
3. Hose Too Heavy. If the hose sags downward t an angle less than 45° , move the weights away from the cleaner, or separate the first two weights away from each other.

Note: The FIGURE 9 shows only model B, a schematic diagram of the pool balance, model# A, C, D with the same balance diagram of the pool.

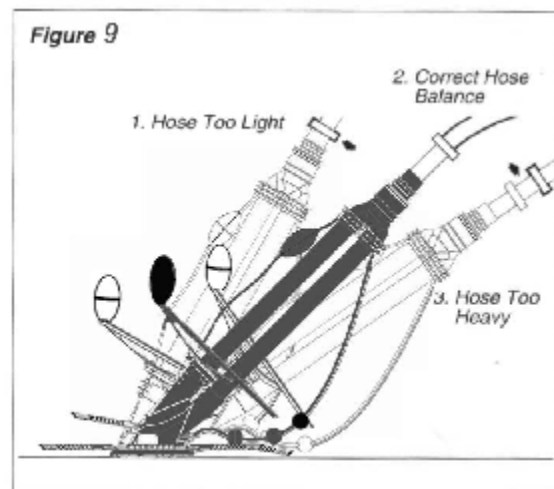

Return Line Water Flow

IMPORTANT: The water flow from your return line can push the cleaner's hose and affect its performance. It may cause the cleaner to steer away from the end of the pool where the return line is located, or it may cause the cleaner to remain in one section of the pool. To correct this, use the eyeball diverter included with your the cleaner.

To install the eyeball diverter:

- 1 First make sure your **pool pump is off**. Remove the original eyeball from the return line at the pool by unscrewing the lock ring.
- 1 Replace the original eyeball with the cleaner eyeball diverter..
- 1 Replace the lock ring and tighten. Make sure the opening of the eyeball diverter points in the proper direction before tightening fully. See "Eyeball Diverter positions" below.

Eyeball Diverter Positions

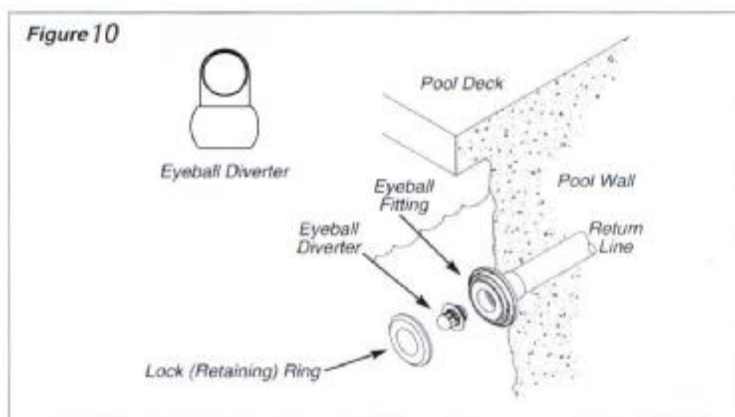

Position the diverter opening to redirect the return line water flow so it does not interfere with the cleaner's movement. Try different positions to see which works best in your pool:

- 1 Flow directed along the side of pool (the tile line).
- 1 Flow directed downward.
- 1 Flow directed against the hose will help steer the cleaner away from obstructions such as stairs and ladders.

After installing the eyeball diverter, **turn the pool pump on**. The cleaner should begin moving across the pool floor vacuuming up debris in its path.

VI. Troubleshooting

Because of the individual characteristics of your pool, some additional adjustment may be required to get the rest performance from your cleaner.

If there seems to be a problem, check these common causes of cleaner problems.

-----Is bottom main drain closed?	Close drain
-----Is filter clean?	Clean filter
-----Is pump strainer basket clean?	Clean basket.
-----Is debris blocking the bottom of the cleaner?	Remove debris.
-----Are there any leaks in the hose?	Replace leaky section
-----Is automatic regulator valve free of debris?	Clean valve.

If the cleaner is not moving or not pulsating.

- l Check to ensure that the main drain and all suction lines are closed, except for the suction line to which the cleaner is attached.
- l Check for debris in the filter or pump basket.
- l Check for debris in the cleaner's flapper. Debris may prevent flapper movement or restrict flow.
- l Pool pump and filter system may be too small (incapable of providing 20 gallons per minute water flow). Consult your pool professional.

If the cleaner stays in one end of the pool.

- l Check the return line water flow and redirect as necessary with an eyeball diverter.
- l Check that hose is long enough to reach to end of pool.
- l Check that the cleaner has proper hose balance.

If the cleaner stays on the main drain.

- l Check to ensure that main drain is closed. A pool professional may need to assist you.
- l Check to ensure that a main drain grate is installed.
- l If main drain is not flush with the pool floor, consult your pool professional.

If the cleaner slows or stops and air bubbles enter the pool at the return line.

Find and correct the air leak that is causing the pump to lose its prime.

- l Check the hose to ensure there are no leaks.
- l Check the vacuum connection. It should be submerged so no air enters the system.
- l Check the pump basket lid for looseness, cracks, and worn or missing O-rings. If you need assistance, contact your pool professional.

If the cleaner pulls air from, or remains at, the water surface.

- l Check to ensure the dive float mechanism is operating freely and the dive float restrictor is installed. (See page 2 for how to install dive float restrictor.)
- l Check the automatic regulator valve for its proper installation and ensure it is not clogged with debris.
- l Make sure the water level is at least 3 inches below the pool deck.
- l Check to insure your the cleaner is operating at the proper speed of 8-12 feet per minute.

If the cleaner stays at the shallow end steps.

- | Check the return line water flow and re-direct as necessary with an eyeball diverter.
- | Check the automatic regulator valve for its proper installation and ensure it is not clogged with debris.
- | Check that hose is long enough to reach the furthest point of the pool, including pool steps.
- | Check that the cleaner has proper hose balance in shallow end.
- | Check to ensure your the cleaner is operating at the proper speed of 8-12 feet per minute.
- | Check to ensure the dive float mechanism is operating freely and the dive float restrictor is installed. (See page 2 for how to install dive float restrictor.)
- | Shorten the roller bumper strap by 1/2 inch. (Pull out upper end of bumper strap from locking end clip attached to swivel head .Cut 1/2 inch off, then return bumper strap into locking end clip.)

If the cleaner tracks in a repetitive pattern.

- | Check the swivel on the top of the cleaner. It should turn freely.
- | Check the return line water flow and re-direct as necessary with an eyeball diverter.
- | Check the cleaner's hose to ensure it has not become bent or kinked. It only takes one bent or kinked hose section to hinder the cleaning coverage. One way to check for kinks in your hose is to lay each section flat on your pool's deck (or other flat surface). The hose should be perfectly straight and flat. **Do not coil the hose when taking your the cleaner out of the pool because it will retain the coil shape, forming a bend or kink.**

To Remove Debris from the Flapper

- | Sometimes debris may clog the bottom of the cleaner and prevent flapper movement or restrict flow. The flapper is located inside the main body and must move freely at all times. You can see the flapper through the opening in the baffle plate, when you turn the cleaner upside down as shown in Figure 11. Jiggle the flapper with your finger or flush the cavity with a hose to force out any debris lodged inside the main body.

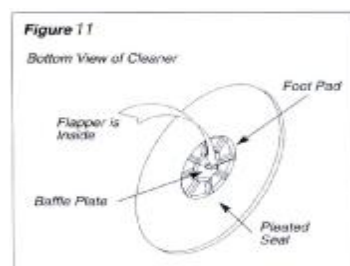

- | If debris is still lodged inside, you must remove the flapper. First, get rid of four lids in the foot pad, unscrew it, and then remove it from the main body. In secession, take out the screw from piffle plate, pull it out and lastly, remove the flapper. See Figure 12
- | Once the debris is dislodged, insert the flapper back into the main body and snap the baffle plate back into position. Be sure that it is securely in place. See Figure 12

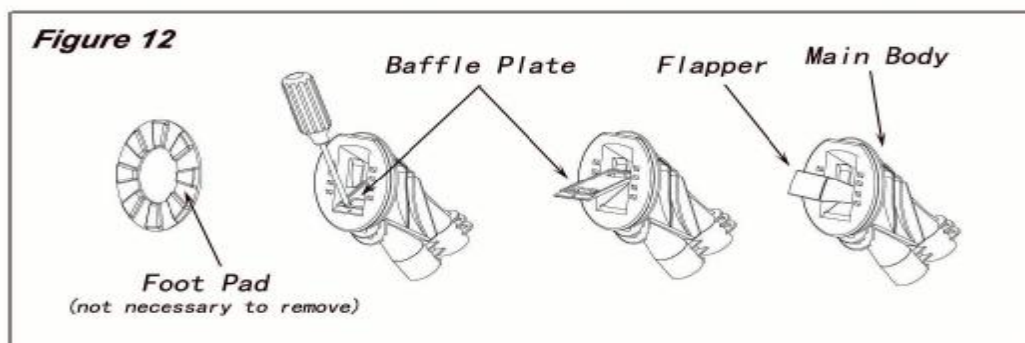

Maintenance

The cleaner requires almost no maintenance. Visually inspect your the cleaner from time to time to make sure that:

- I** The flapper is moving freely and is not obstructed by debris.
- I** The foot pad is not excessively worn. When the traction pads on the bottom have worn down, it is time for replacement.

When storing the cleaner, do not coil the hose. Lay the hose flat in an area protected from direct sunlight. If hose sections are disconnected, try not to disturb the hose weight locations.

The cleaner's hose is specially designed to ensure optimum performance from the cleaner. Should replacement be required, insist on genuine the cleaner hose.

Disclaimer of Liability-About Your Pool and the cleaner

There are a multitude of factors that contribute to the life of your pool. The the cleaner automatic pool cleaner is a very passive product that will have no impact on pool life.

Please be aware that over time, deterioration, discoloration and brittleness of any pool finish can be caused separately by, or in combination with, age, an imbalance in pool water chemistry, improper installation and other factors. An automatic pool cleaner, such as the cleaner, will not remove or cause wear on "good" pool plaster. In fact, the opposite is true-pool plaster will eventually cause wear on the cleaner.

The same situation holds true for vinyl-lined in ground swimming pools, because vinyl liners are also affected by the environment and factors such as pool water chemistry, sunlight and the pool's surroundings. Therefore over time, vinyl can become brittle and weak. In addition, vinyl-lined pools are affected by the workmanship, composition and installation of the liner and the workmanship and quality of construction of the supporting walls and pool base. There are all factors which can contribute to liner failure. The existence of any of these type of conditions in your pool is not caused by the use or operation of the cleaner. The manufacturer disclaims any liability for repairs or replacement to any of these structures or components of the customer's pool.

The pool owner must assume all responsibility for the condition and maintenance of the pool's surface, water and deck.

Parts List: 73240 73250 73260 73274

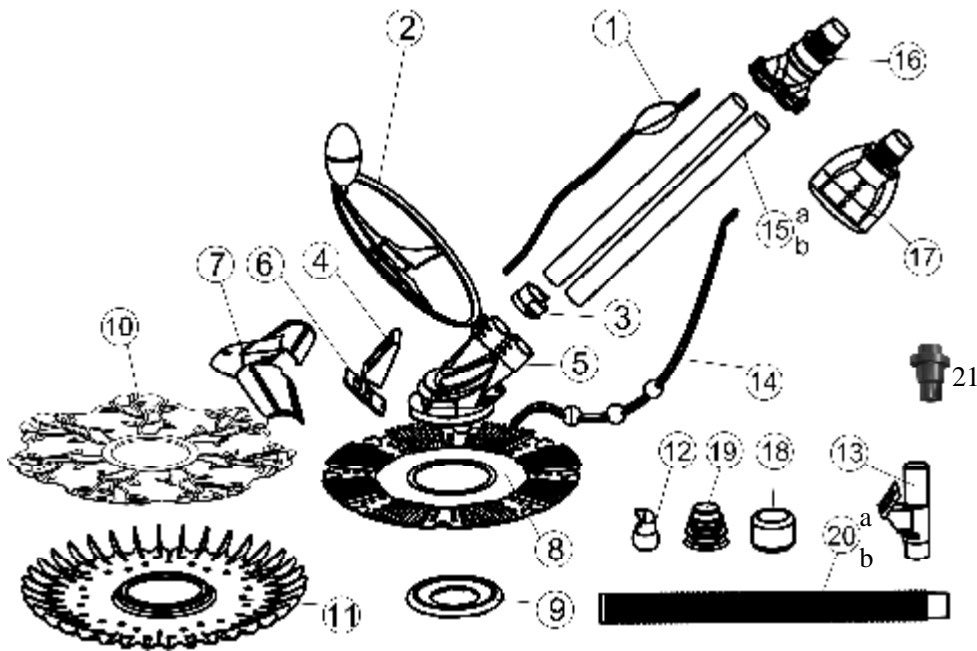

Ref. NO.	Part NO.	73240	73250	73260	73274	QTY
1	647325072		√			1
2	647325073	√	√	√	√	1
3	647325024	√	√	√	√	1
4	647325012	√	√	√	√	1
5	647325071	√	√	√	√	1
6	647325013	√	√	√	√	1
7	647325076	√		√		1
8	647325019		√		√	1
9	647325020	√	√	√	√	1
10	647325037	√				1
11	647325036			√		1
12	647325021	√	√	√	√	1
13	647325075	√	√	√	√	1
14	647325014	√	√	√	√	1
15a	65748020001	√		√	√	2
15b	65748020052		√			2
16	647325074		√		√	1
17	647325078	√		√		1
18	647325025	√	√	√	√	3
19	647325001	√	√	√	√	1
20a	647325077	√	√	√	√	1
20b	647327201001				√	10
21	65758025933				√	1